

L109(H), L120(I),
L127(A), L130(C)
Navigationsempfänger-
baugruppe
L34(O), L50(D), L126(Q)
Radioempfangersbaugruppe
L146(P), L149(J)
Radio- und Display-
empfänger-Einheit

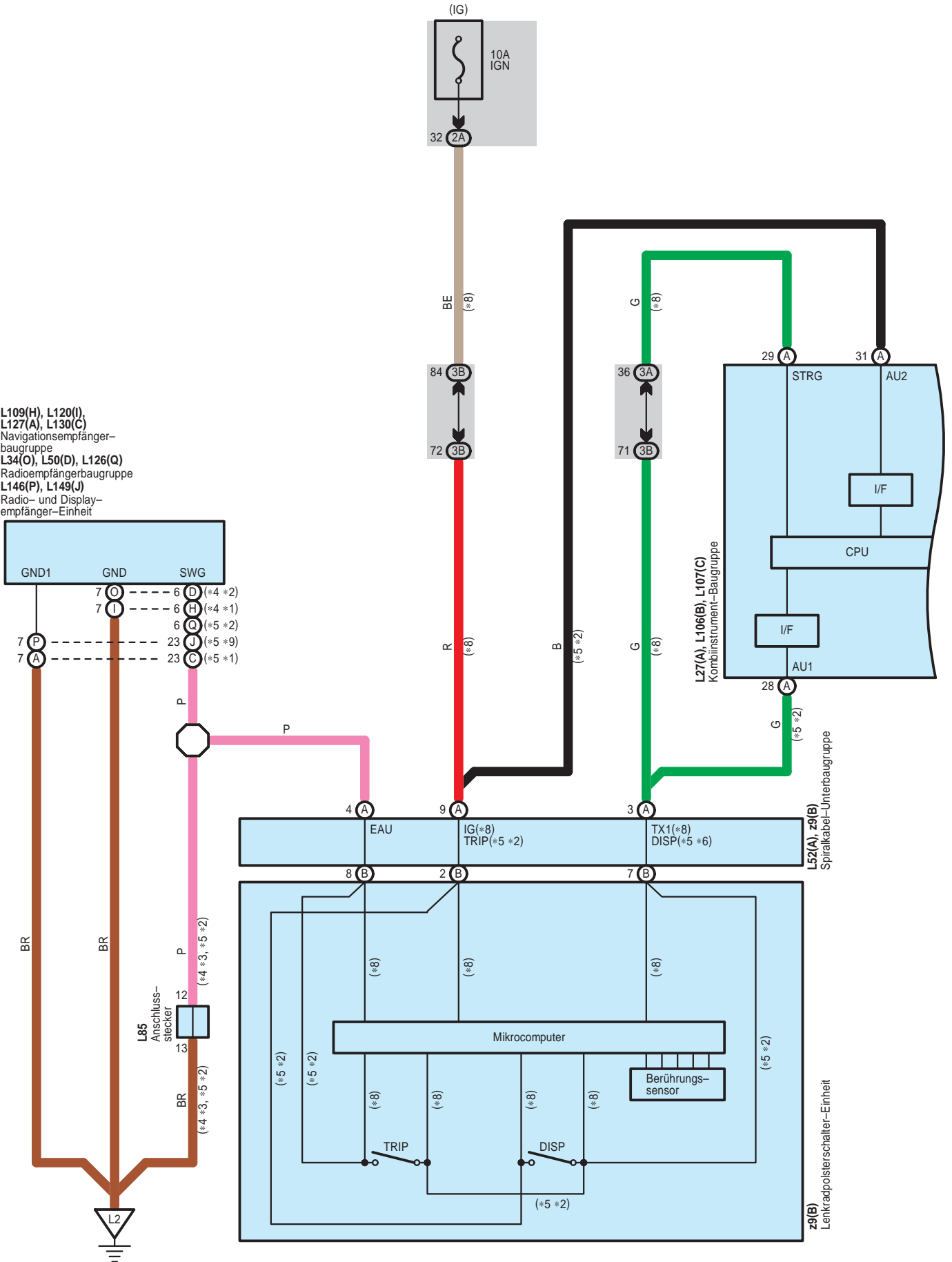

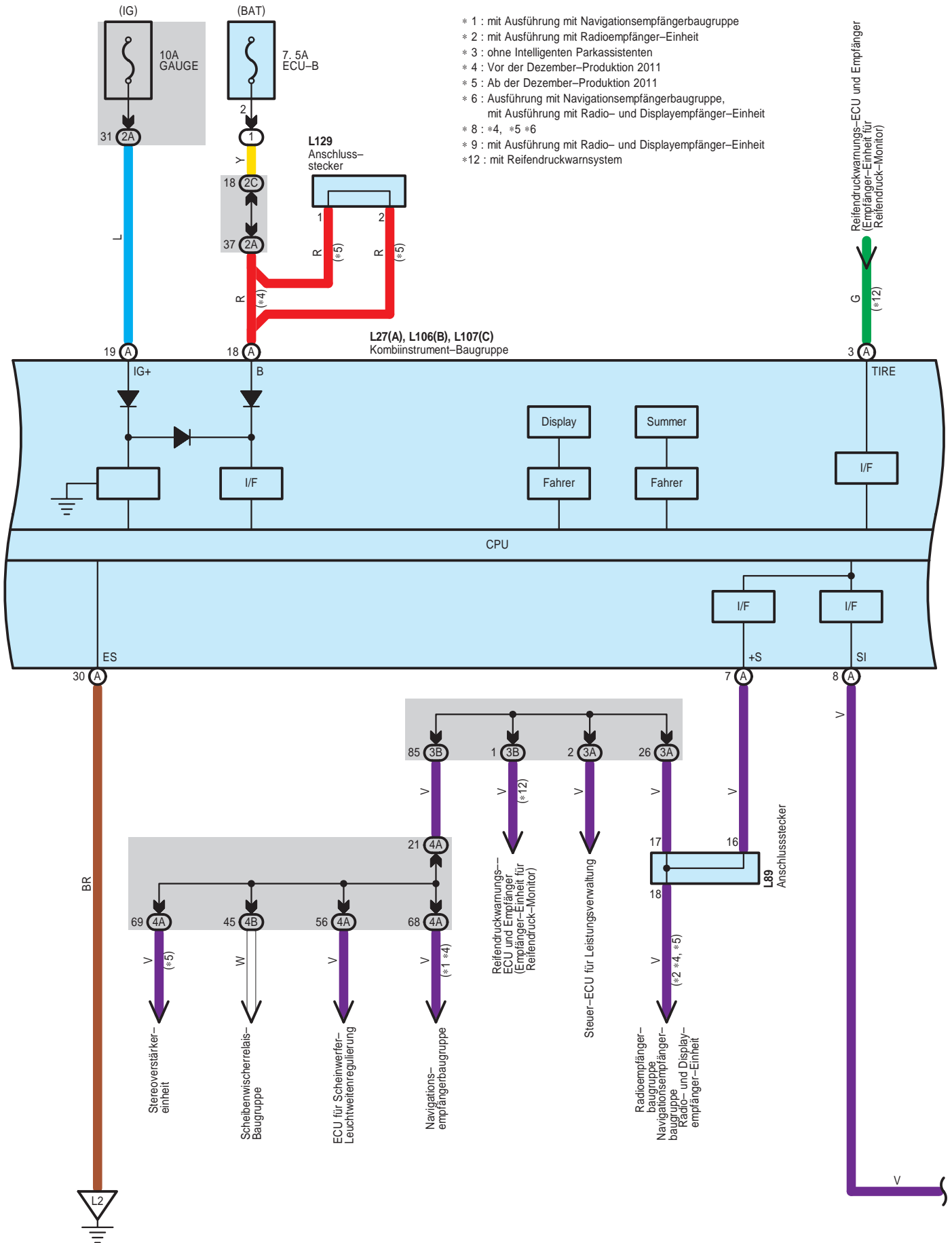

L111
Kombiinstrument-Spiegel

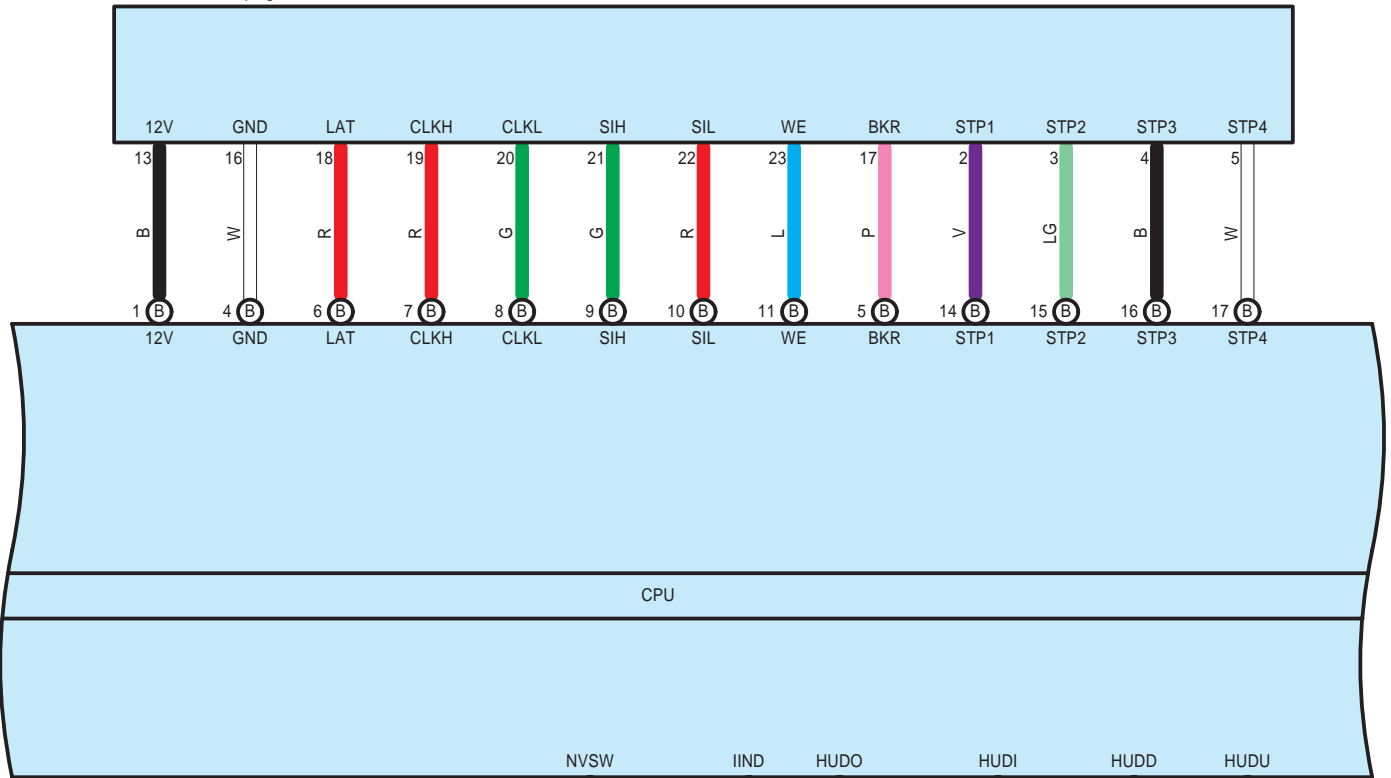

L27(A), L106(B), L107(C)
Kombiinstrument-Baugruppe

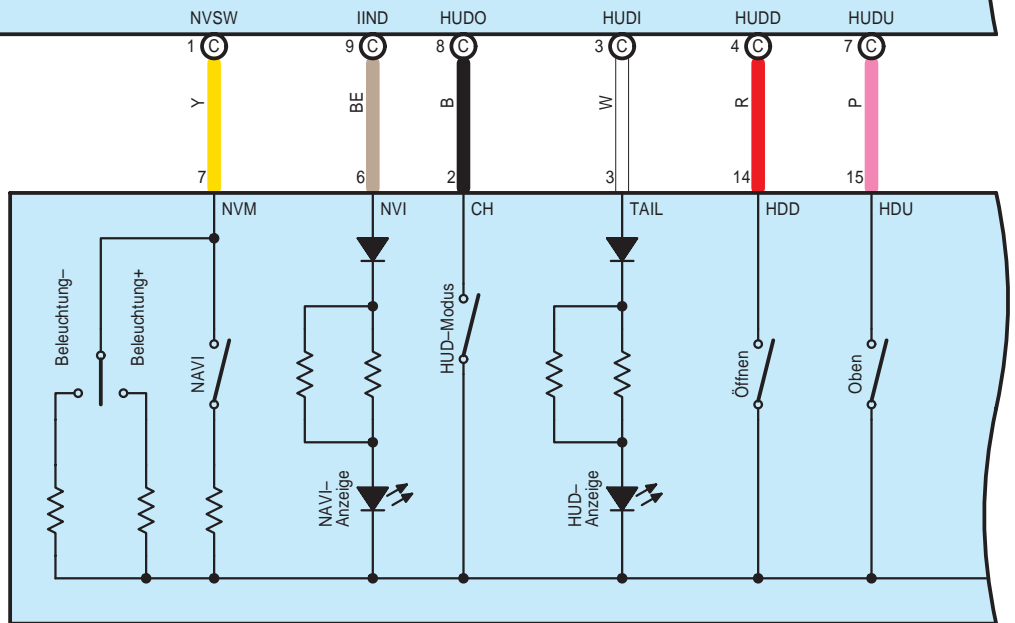

L57
TRIP-Schalter



- * 4 : Vor der Dezember-Produktion 2011
- * 5 : Ab der Dezember-Produktion 2011
- *10 : Brasilien
- *11 : Außer Brasilien

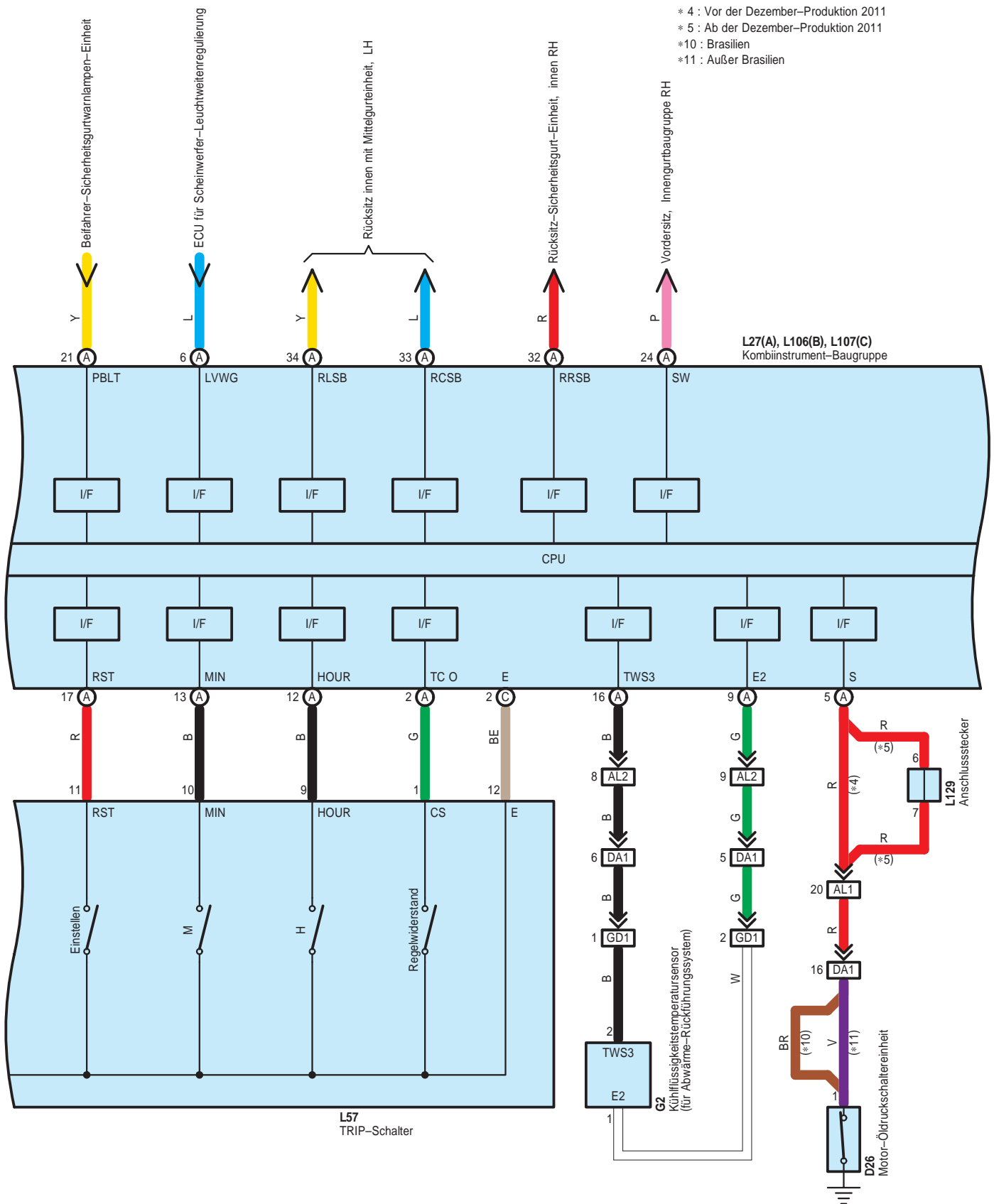

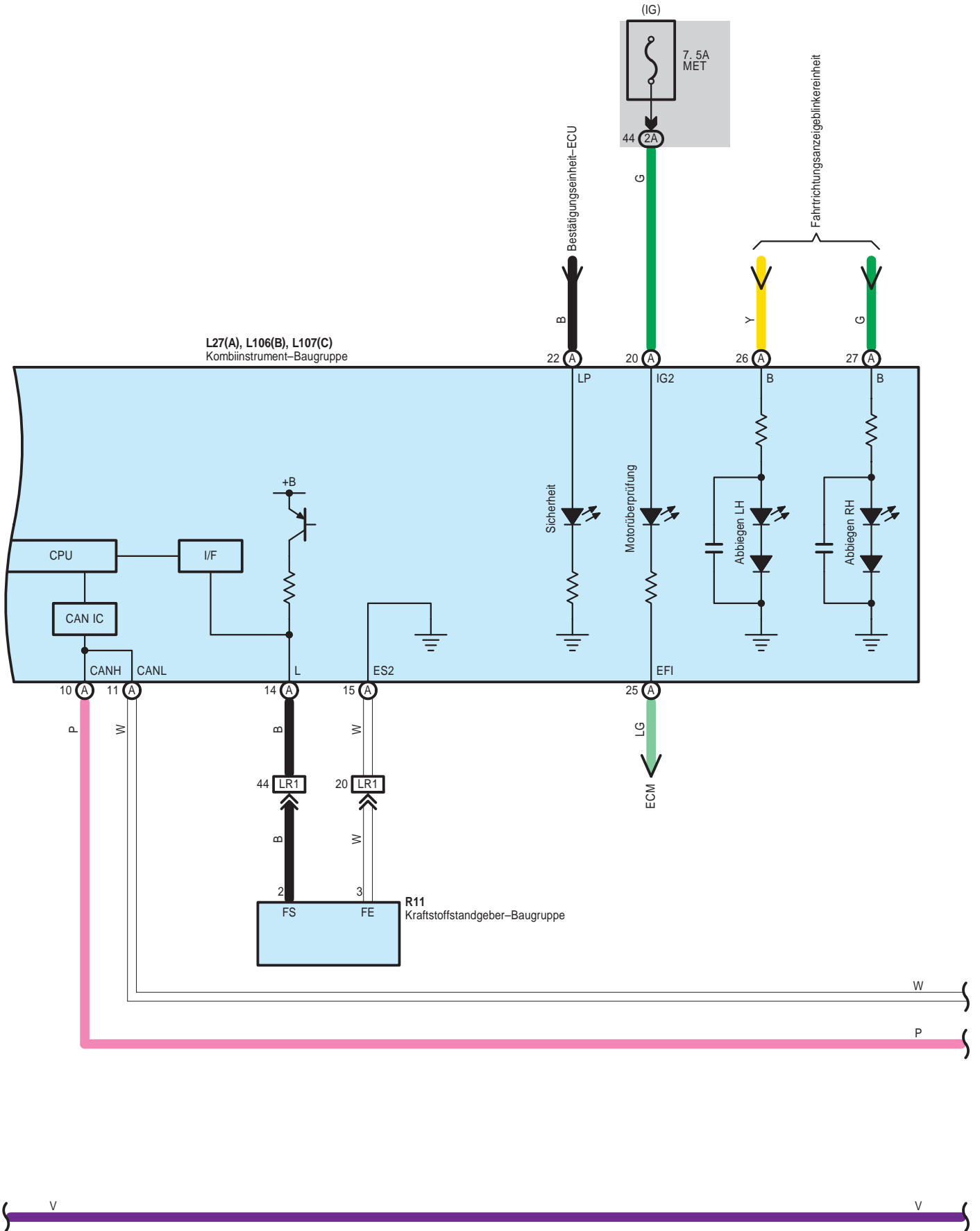

Kombiinstrument <LHD>

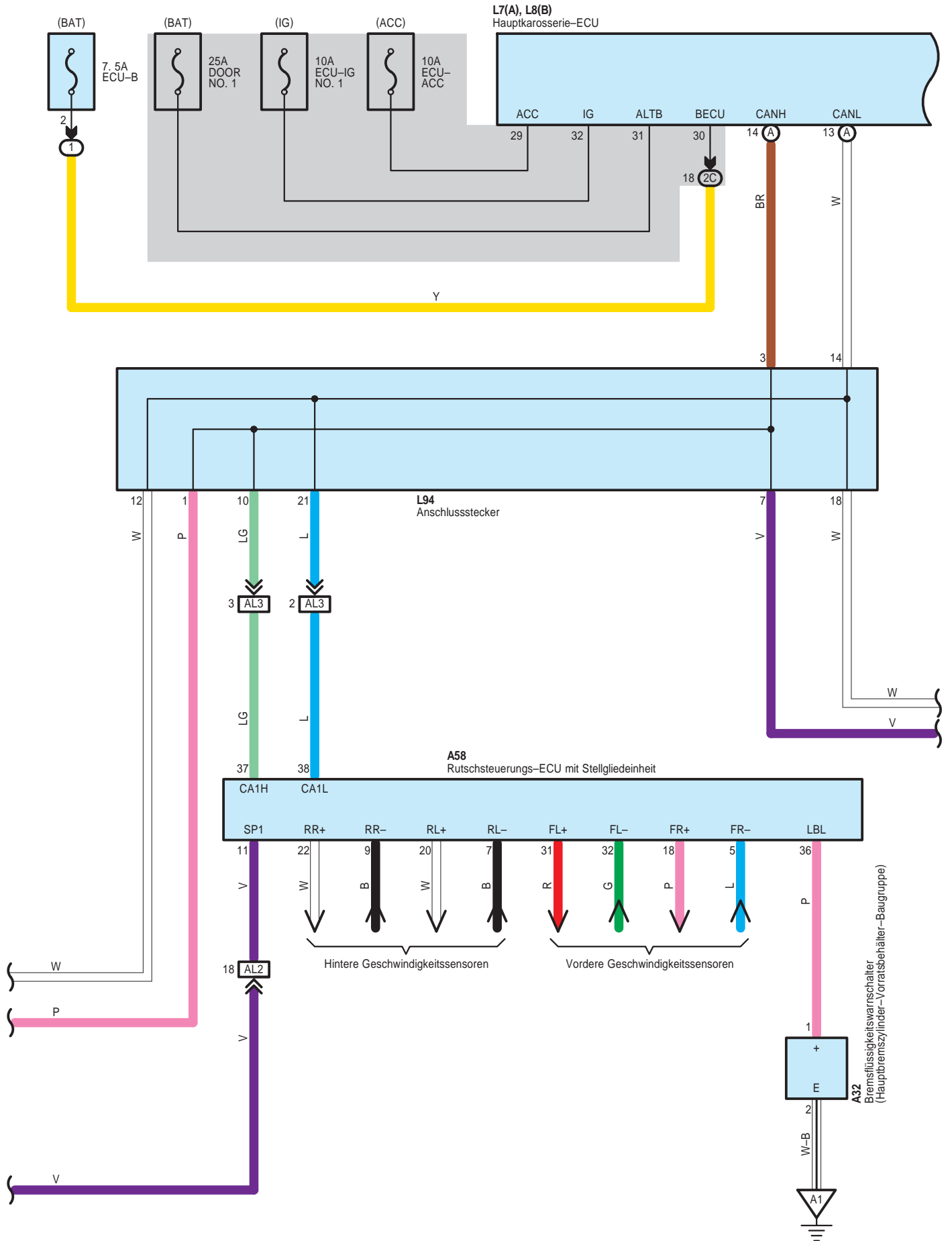

L7(A), L8(B)
Hauptkarosserie-ECU

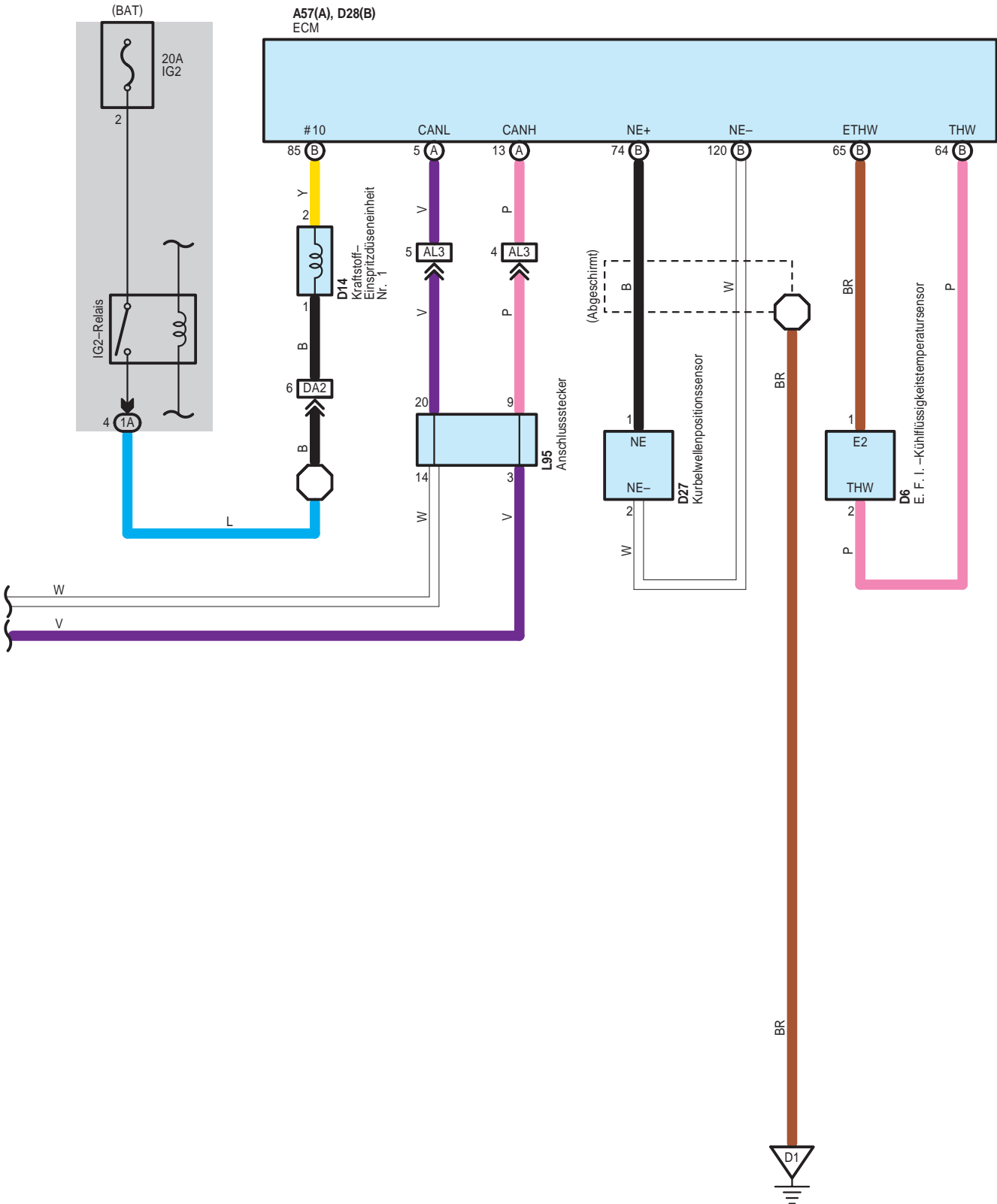

L7(A), L8(B)
Hauptkarosserie-ECU

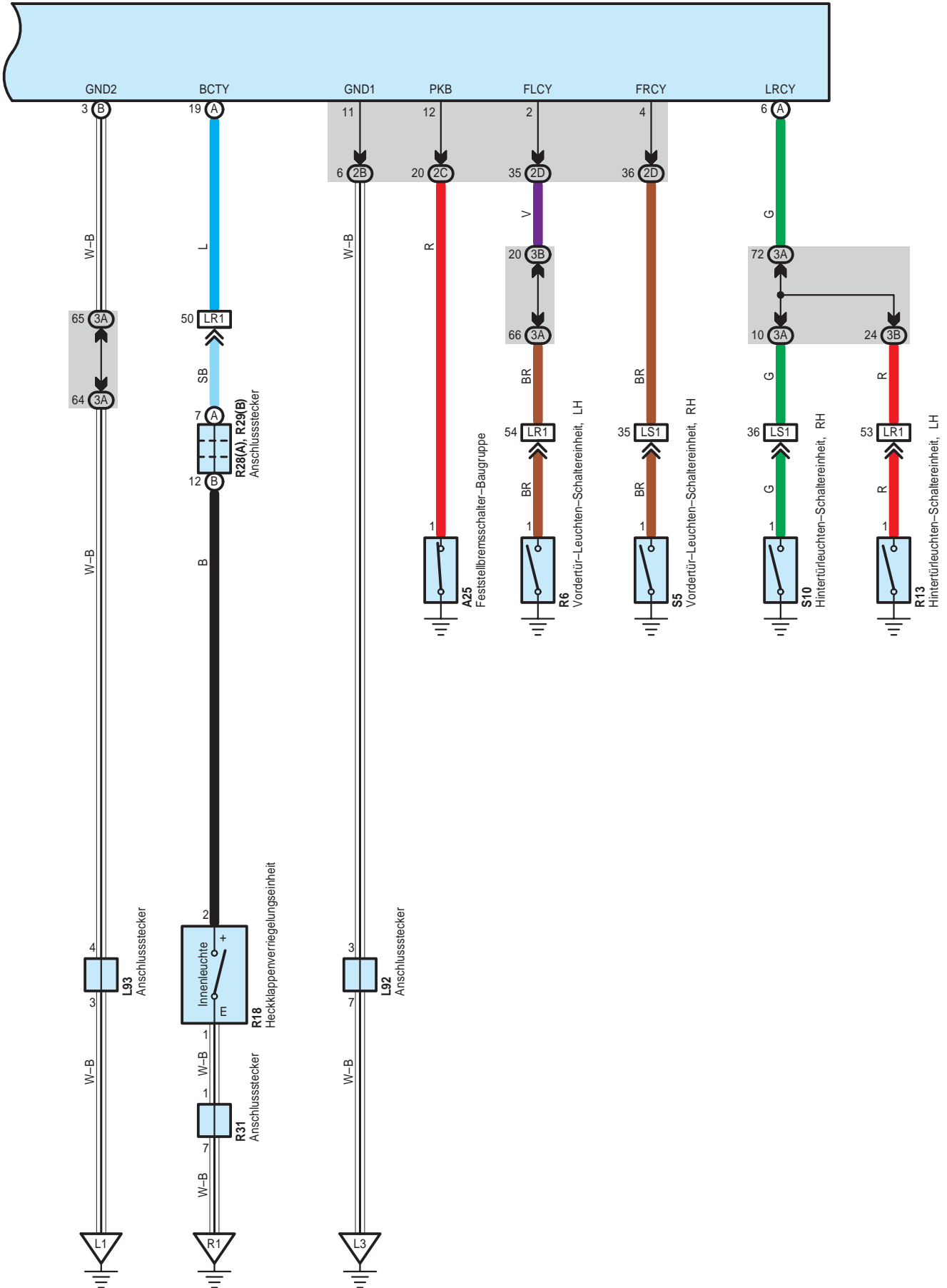

Kombiinstrument <LHD>

A 25
Weiß



A 32
Schwarz

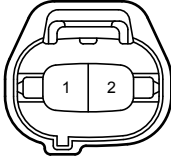

A 57
Schwarz

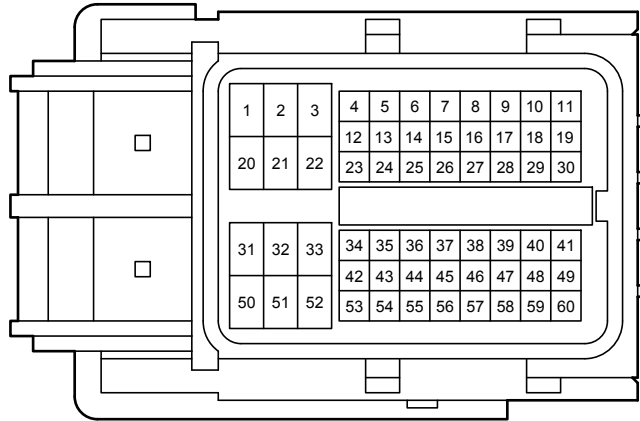

A 58
Grau

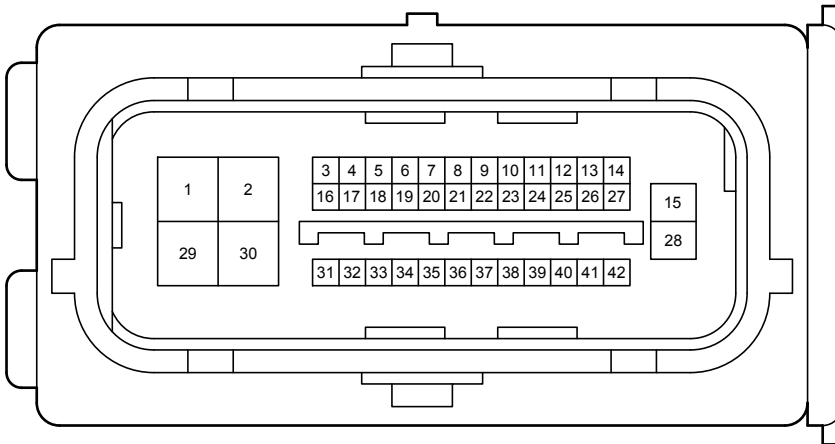

D 6
Schwarz



D 14
Schwarz

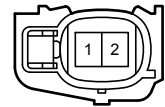

D 26
Grau



D 27
Schwarz

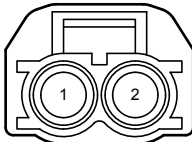

D 28
Schwarz

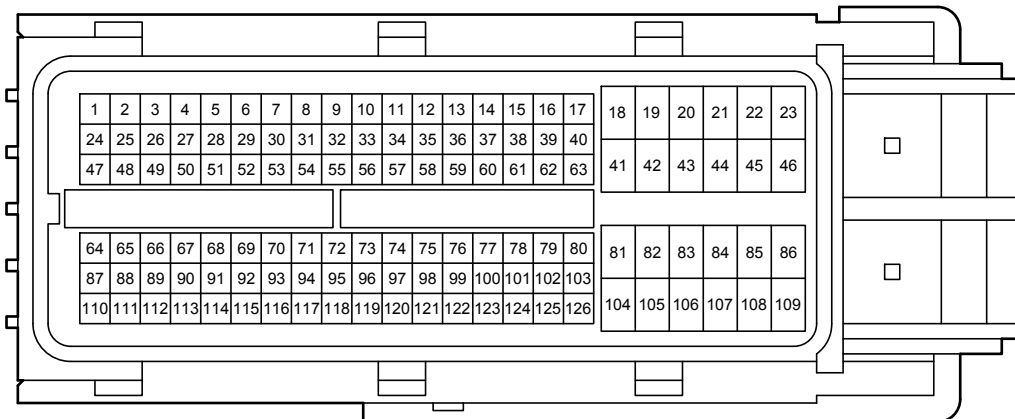

G 2
Schwarz



L 7
Weiß

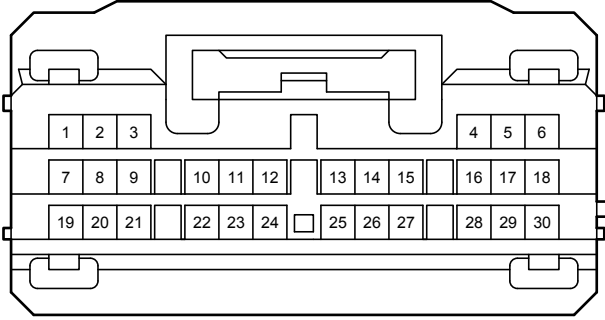

L 8
Weiß

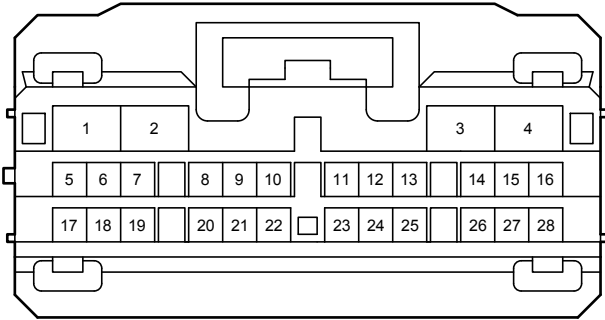

L 27
Weiß

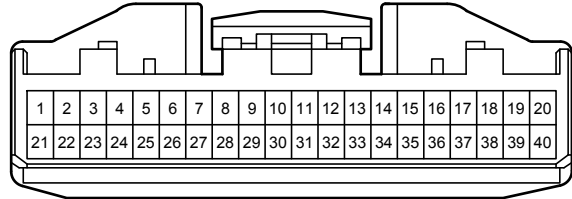

L 34
Weiß

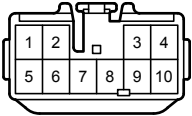

L 50
Weiß

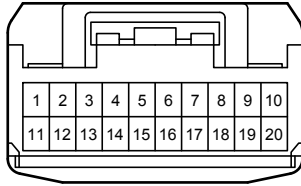

L 52
Schwarz

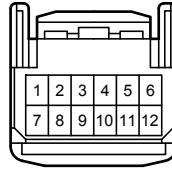

L 57
Schwarz

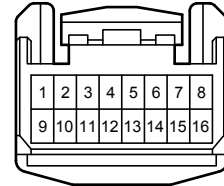

L 85
Weiß

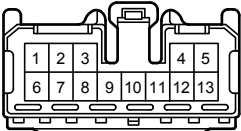

L 89
Schwarz

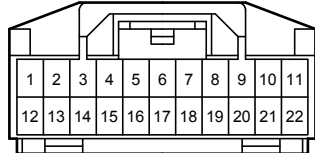

L 92
Weiß

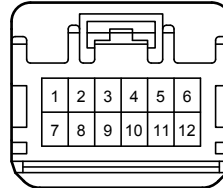

L 93
Weiß

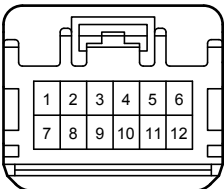

L 94
Weiß

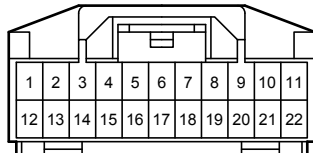

L 95
Weiß

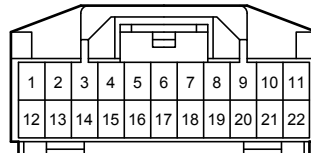

L106
Weiß

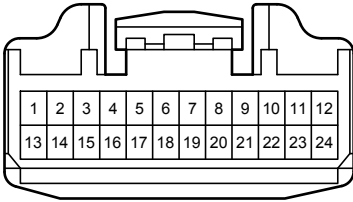

L107
Weiß

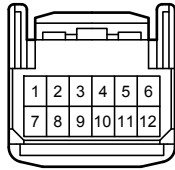

L109
Weiß

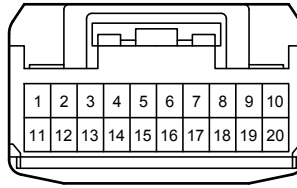

L111
Weiß

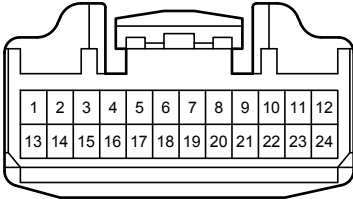

L120
Weiß

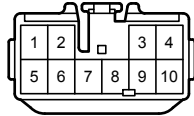

L126
Weiß

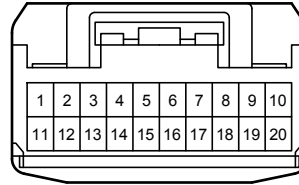

L127
Weiß

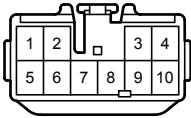

L129
Grau

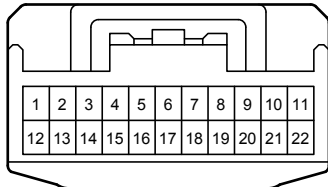

L130
Weiß

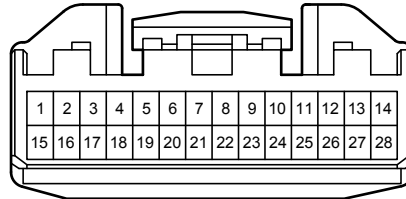

L146
Weiß

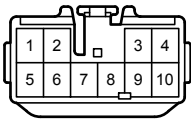

L149
Weiß

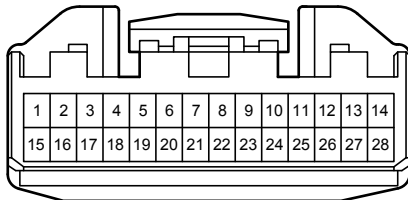

R 6
Schwarz



R 11
Orange

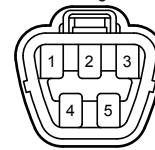

R 13
Schwarz



R 18
Weiß

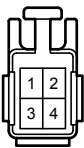

R 28
Weiß

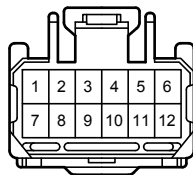

R 29
Weiß

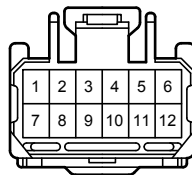

R 31
Weiß

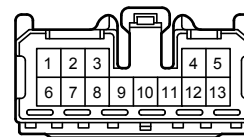

S 5
Schwarz



S 10
Schwarz



z 9
Weiß

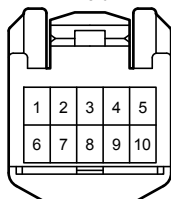

1A
Weiß

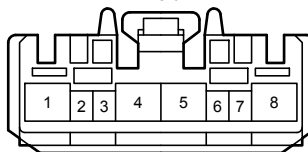

2A

Weiß

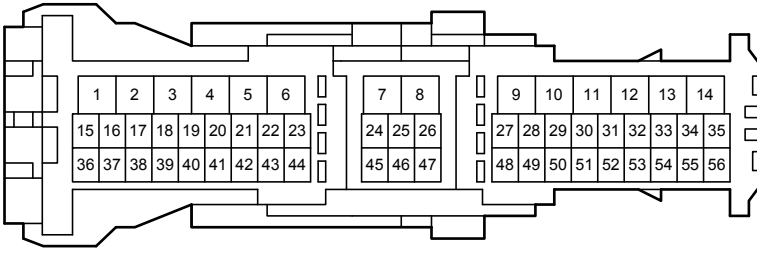

2B

Weiß

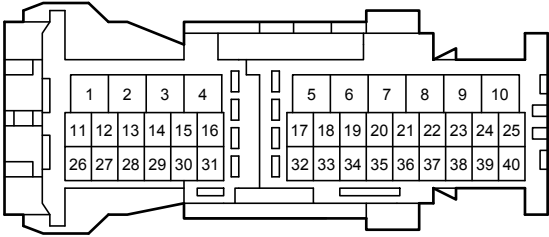

2C

Weiß

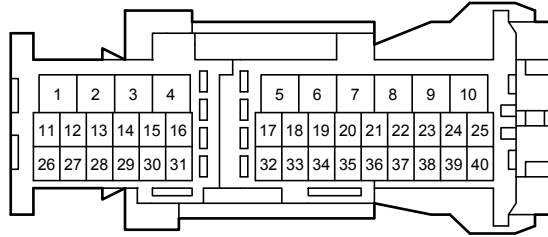

2D

Weiß

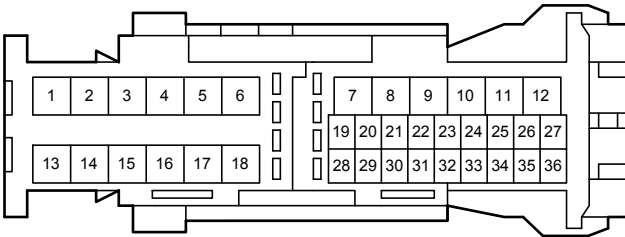

3A

Weiß

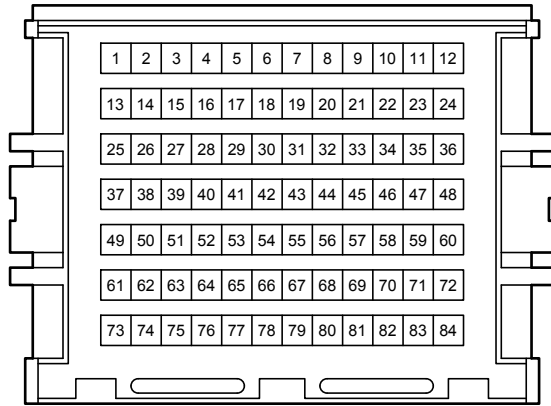

3B

Weiß

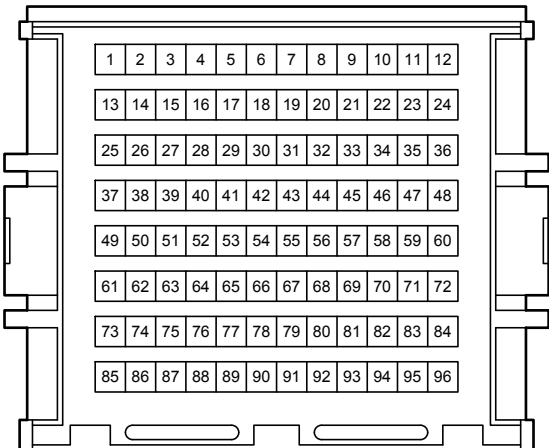

4A

Weiß

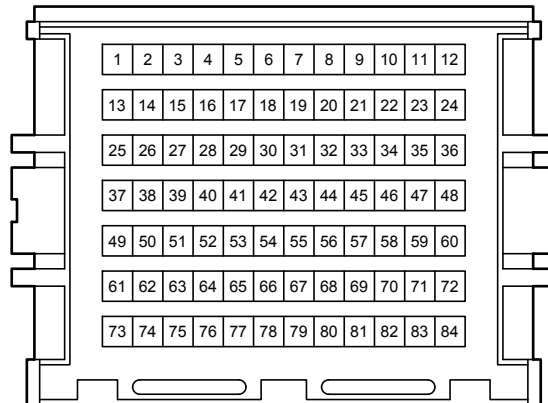

4B
Weiß

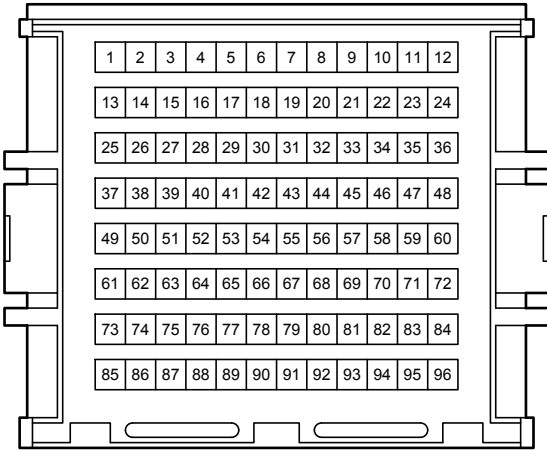

AL1
Blau

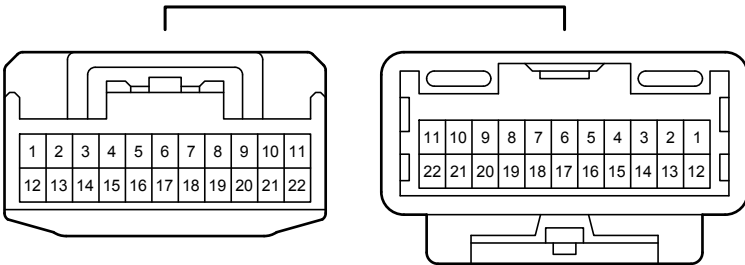

AL2
Grau

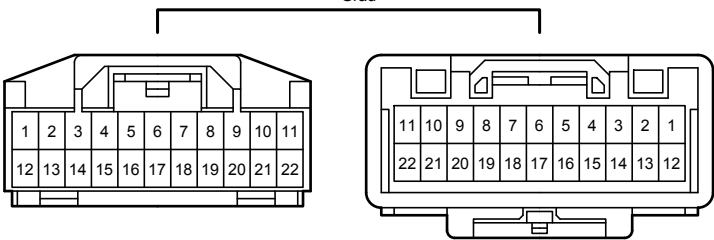

AL3
Weiß

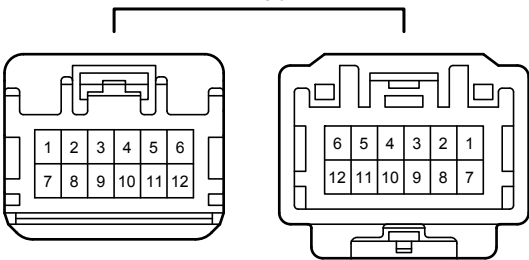

DA1
Weiß

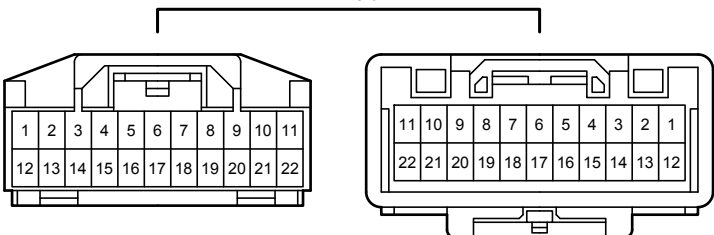

Kombiinstrument <LHD>

DA2
Weiß

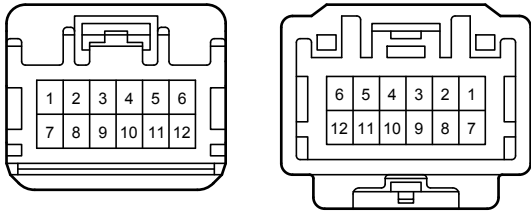

GD1
Schwarz

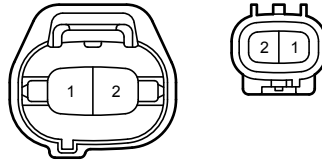

LR1
Weiß

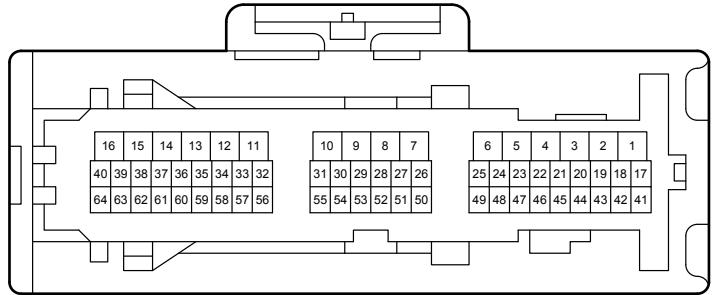
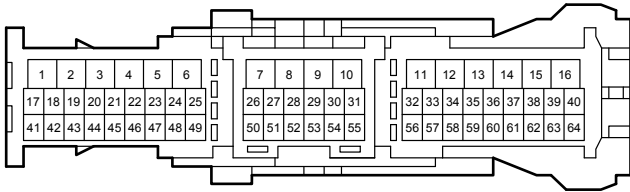

LS1
Weiß

